

MINICENTRALE COMPACT HY10

HY10 MINI POWER PACK

Per impianti scarrabili con sollevamento cassa
For trailer lifting

SCARRABILE SOLLEVAMENTO CASSA TRUCK'S TRAILER LIFTING

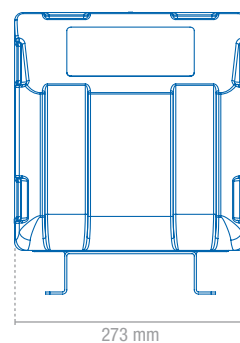
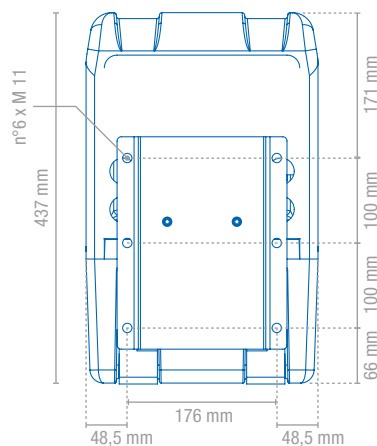
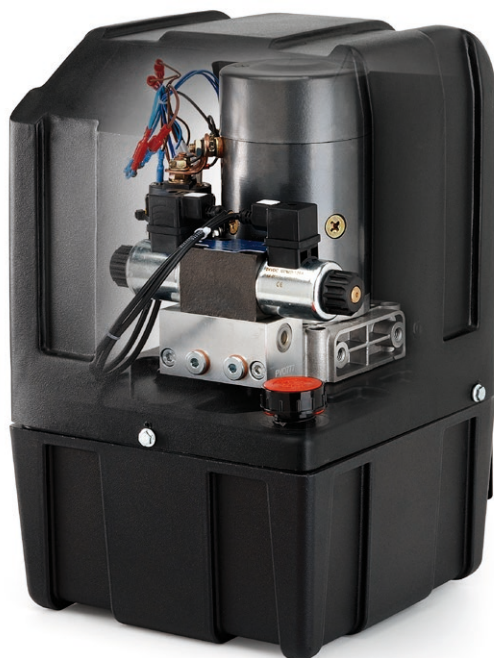

IT Minicentrale con motore CC da 24V 2000W S3¹⁾, completo di termocoppia e teleruttore da 200 A. Serbatoio da 10 litri in termoplast con cuffia e supporto di montaggio.

La pressione massima ottenibile è di 300 bar. Fornita con presa per collegamento pulsantiera o radiocomando.

EN Mini power pack with 24V 2000W S3 DC motor¹⁾, completed of thermocouple and starting relay 200 A. With 10 lt termoplast plastic tank and mounting support.

Max. pressure available is 300 bar. Completed with plug for remote and radio control.

(1) Altre tensioni disponibili a richiesta / Other voltages available on request

CODICE / CODE **DESCRIZIONE / DESCRIPTION**

60S10G24SCHY Minicentrale 24V per scarrabile sollevamento cassa
24V truck's trailer lifting power pack

SCHEMA IDRAULICO / HYDRAULIC SCHEMATIC

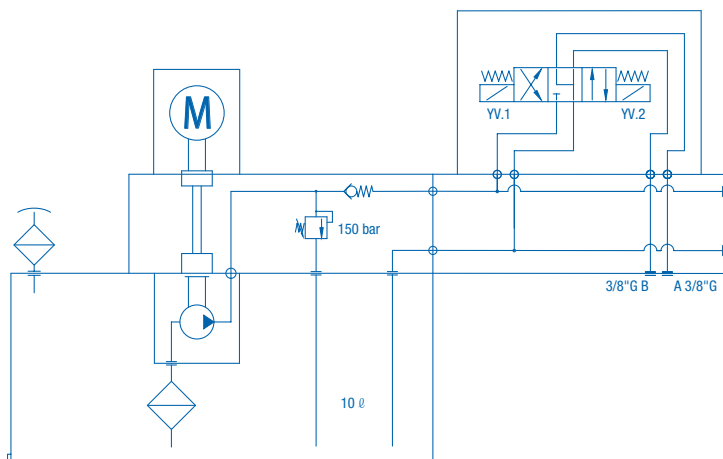

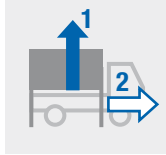
ACCESSORI
 ACCESSORIES

2

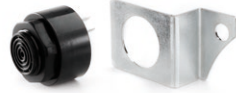
COD.AC78VCOMM0HY
 COMMUTATORE A CHIAVE
 ON-OFF SWITCH

COD.AC151CIC02HY
 CICALINO con staffa e pressostato cablato 2 m
 BUZZER with bracket and pressure switch, 2 m wiring

COD. AC34ZKEME0HY
 KIT POMPA A MANO di emergenza 8cc/ciclo D.E.
 Emergency HAND PUMP KIT 8cc/cycle double acting

H



oppure / or

R

COD.AC150EPES4HY (AC150EPES7HY)
 PULSANTIERA a due pulsanti EPE con cavo 4 m (7 m)
 EPE REMOTE CONTROL 4 m (7 m) wiring

COD.AC150PLMS7HY
 PULSANTIERA con cavo lineare 7,5 m
 REMOTE CONTROL with 7,5 m linear wiring

COD.AC150PSMS5HY
 PULSANTIERA con cavo lineare (5 m) + spiralato (0,5 m)
 REMOTE CONTROL with linear (5 m) + twisted
 (0,5 m) wiring

COD.AC62KR2C 0HY
 KIT RADIOCOMANDO con pulsante di emergenza
 a 2 CH per D.E. e S.E.
 RADIO CONTROL 2 CH with emergency button for
 double acting and single acting

(2) A richiesta con connessione presa-spina. / Heavy duty plug-socket on request. - COD. AC78MPRSP0HY

DIVISORE DI FLUSSO - COD.AC071DS416HY

Il divisore di flusso a 4 stadi Hydroven, provvisto di valvole di azzeramento e scarico in mandata, consente l'adeguato apporto d'olio e la giusta sincronia ai cilindri centina.

FLOW DIVIDER - COD.AC071DS416HY

Hydroven 4 stages flow divider, with resetting valves, is the perfect solution for truck trailer's roof lifting applications.

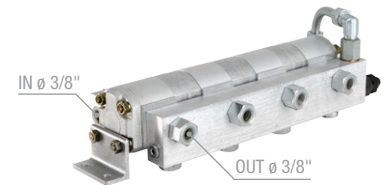
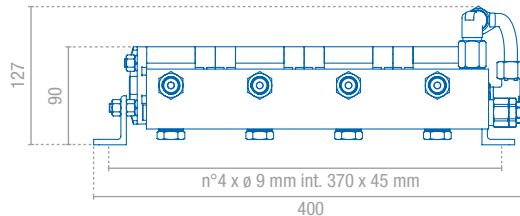
**CILINDRI PER SCARRABILE
 SOLLEVAMENTO-CASSE**

Kit cilindri (2 destri + 2 sinistri) a doppio effetto, completi di valvole a doppio ritegno pilotato.

CYLINDERS FOR BODY TRUCK LIFTING

Double acting cylinder's kit (2 right + 2 left), with double pilot check valves.

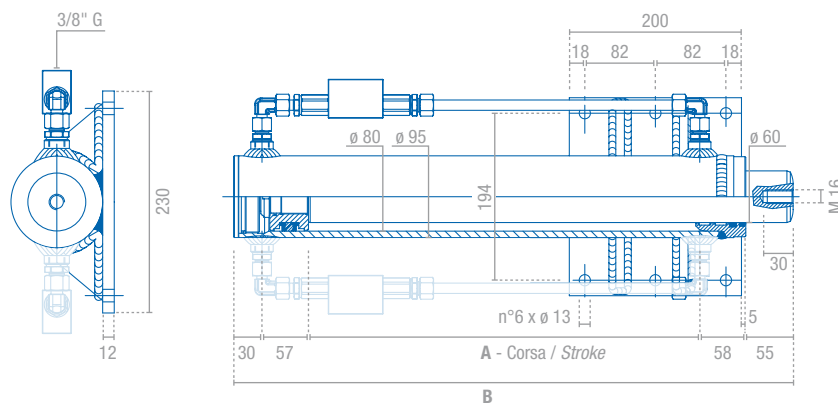

A	B	CODICE / CODE
450 mm	650 mm	AC451S8450HY
380 mm	580 mm	AC451S8380HY

 Tubi alta pressione raccordati su richiesta
 High pressure hoses on request

HYDROVEN si riserva il diritto di apportare senza alcun preavviso qualsiasi modifica alle caratteristiche tecniche indicate nel presente documento. I dati ivi riportati non sono vincolanti. HYDROVEN reserves the right to modify the technical data mentioned into this document without notice. The herewith mentioned data are not bounding.